

A Visual Guide to Wood Stove Inspections for Energy Auditors

Prepared by the Alliance for Green Heat, October 2021

Introduction

This guide is intended to show common examples of safety problems with wood stove installations. It is NOT intended to be exhaustive, and it is NOT intended to guide repairs. To fix or repair these problems, a stove expert should be consulted such as a National Fireplace Institute (NFI) or a Chimney Safety Institute of America (CSIA) certified expert. Thanks to Russ Dimmit at CSIA, Larry Brockman at EPA and Kelly Cutchin, DOE WAP Trainers' Consortium for their assistance with this project.

Exterior Stove Inspection

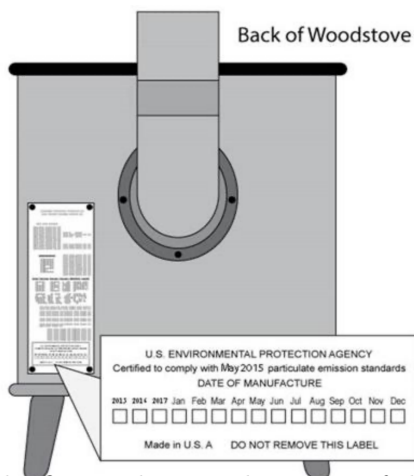

One of the first tasks is to determine if the stove is EPA certified by checking for the metal certification label on the back of the stove. This metal plate may also have required clearances for the stove.

Clearances

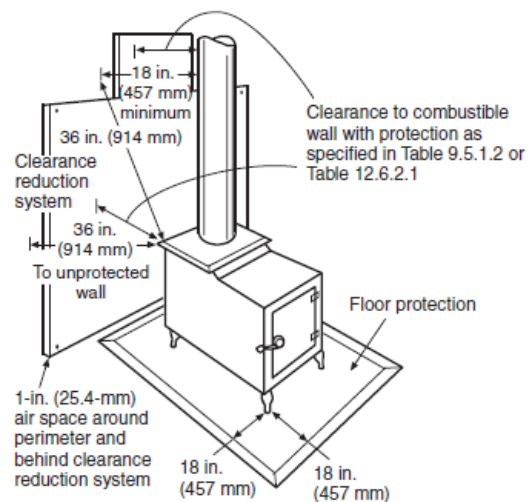

Insufficient clearances from combustable materials are common and often not easy to remedy. Hearth pad should extend beyond the stove per each installation manual.



Clearances must be checked between the stove and the wall, the pipe and the wall, the stove and furniture or firewood and the stove to windows. NFPA (National Fire Prevention Association) 211 has applicable standards.



This stove is placed far too close to the window, which has combustibles materials, even if they're not wood.

Glass



Cracked glass in a door that is intact may not leak combustion gases, but weakens the structural integrity of the stove and needs to be replaced.



Dirty glass is a sign of poor combustion, which also often leads to creosote formation. If glass gets dirty quickly, it means the wood is wet, the stove is not getting enough air, or some other issue which must be addressed.

Hearth Pad

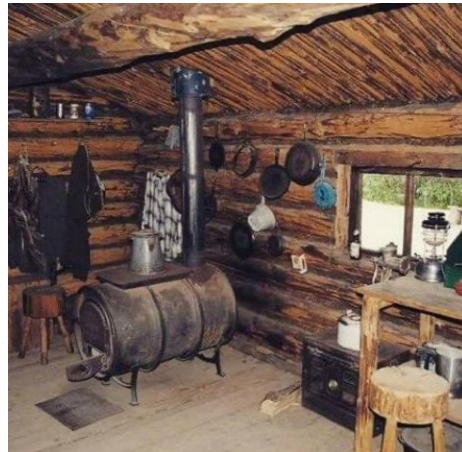

This stove lacks a protective pad under the stove and shows obvious signs of excessive heating of the wall behind the stove. Barrel stoves, like the one shown, are made from kits and are never EPA certified.

Creosote



Check for signs of creosote running down the stove pipe. This is a very bad sign and means dangerous creosote is likely forming in the pipe, and that the pipe may have been installed upside down.

Indoor Air Pollution



Smoke spillage into the room is far more common with fireplaces and often easy to spot. With wood stoves, however, smoke backdrafting and temporary spillage during reloading can also occur. An auditor may smell stale smoke and should ask the occupant if they ever smell it.

Stove Inserts



Wood stove inserts present inspection difficulties. It is usually difficult to assess the stove exterior, confirm if the stove is certified, and whether it has a properly connected liner.

Mobile Homes



Wood stoves in mobile home must meet HUD standard UM-84, indicating that the stove is especially approved for mobile homes. These guidelines require the stove to be attached to a double wall chimney, secured to the floor, not be in a bedroom, and have a dedicated outside air supply.

Dedicated Outside Air Supply



A dedicated outside air supply is important for very tight homes, and it is required in mobile homes and in all new installations in Washington state. Only certain stoves come with optional outside air kits.

Pellet Stoves



Pellet stoves also need to be checked for EPA certification, floor protection, clearances, cracked glass, etc., although they require smaller hearth pads and shorter clearances.

Interior Stove Inspection

Baffles



Virtually every EPA-certified stove has a baffle that prevents the smoke from going straight up the flue. The baffle is often a permanent metal structure, but it can be made of brick, stiff ceramic board, or a flexible ceramic blanket. Replace if it is damaged or has been removed.



This stove's baffles are made of firebrick, and one is missing, which causes more smoke and reduces the efficiency of the stove.

Air Tubes



Most certified stoves have air tubes in the top of the stove that deliver pre-heated air for secondary combustion. If they are warped and out of place, like this one, they need to be replaced.



This shows a secondary air tube that has come loose in a new, unused stove. It may be easy to fit it back in.

Gaskets



Gaskets around the door of a stove should be intact and have some cushion left in them. If they are hard and flattened, they need replacing.

Firebrick



Most stoves have firebrick, and it is often cracked, which is normal. If it's just cracked but otherwise intact, it's OK.



Once firebrick becomes this worn and begins to crumble and fall apart, it must be replaced.



Check if the chimney has a cover and is properly protected from the elements.

Ash Disposal



Ashes should be placed into a receptacle designed for hot ashes. If you see a plastic bucket or something else nearby, that is a problem.

2-10 RULE 1

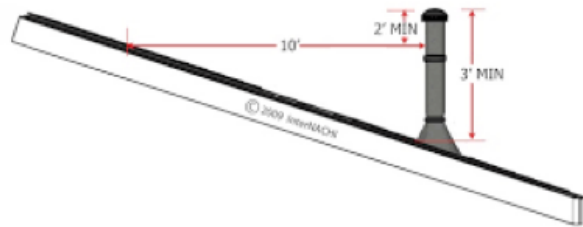

At a minimum the chimney pipe needs to extend 2 feet above the peak of the roof and 10 feet from the peak of the roof. This is known as the 2-10 rule.

Exterior of House

Chimney and Chimney Cap



A vital part of a stove inspection includes a visual inspection of the chimney to see whether there are obvious signs of creosote build-up that indicate the flue is likely in a dangerous condition.

Pellet Stove Venting



Pellet stoves can be direct vented out the wall of the house but must terminate a distance off the ground per manufacturers specifications to protect against getting clogged by snow. This one is likely too close to the ground.

Additional Topics

Catalysts

Signs of catalytic combustor deterioration

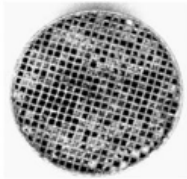

Clogging from ash/soot

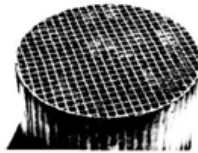

Creosote buildup/tarring

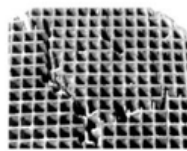

Cracking

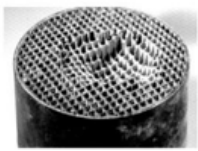

Crumbling

These conditions mean it is time to replace your combustor!

The inspector should determine if the stove has a catalytic converter, and whether it can be easily accessed. It should be noted if the catalyst appears to be broken, cracked, missing or clogged with fly ash or creosote.



Catalytic stoves should also have a stove-top thermometer to indicate when the catalyst should be engaged.

Firewood Storage



Finally, a really complete inspection, particularly where wood is the primary fuel of the house, will check if the wood supply is split and covered.



If there are signs of poor combustion or wood appears to be unseasoned, the inspector/ homeowner should split a piece or two of wood and test the freshly split side with a moisture meter to see if the moisture content is under 20%.

EPA Stove Database

The EPA maintains a database of stove models that are currently certified and those that used to be certified. This database includes the efficiency and particulate matter (PM) emissions values for each model.



To determine the exact clearances around a stove and the size and type of hearth pad required, you must refer to the metal plate on the rear of the stove and/or the stove's owner's installation manual. Manuals for EPA certified stoves should be easily located on the internet, including some older stove manuals.

Smoke and CO Alarms

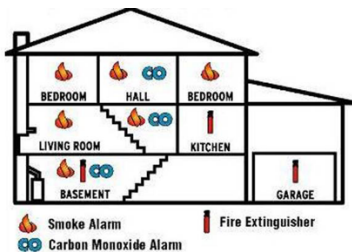

Check that smoke and CO alarms are present and working.

Additional Resources

1. Alliance for Green Heat
www.forgreenheat.org
2. Stove Inspection Videos
www.redfeather.org/healthy-heating
3. EPA Burn Wise
<https://www.epa.gov/burnwise>
4. Chimney Safety Institute of America
<https://www.csia.org>
5. National Fireplace Institute
www.nficertified.org
6. ANSI/BPI 1200, Annex J Stove Inspections
<http://www.bpi.org/sites/default/files/ANSI%20BPI-1200-S-2017%20Standard%20Practice%20for%20Basic%20Analysis%20of%20Buildings.pdf>
7. Canadian WETT Wood Stove Inspections
www.wett-inspection.com/wett-inspection-need-one
8. Installation Permits and Insurance Considerations
www.forgreenheat.org/consumer_resources/permit.html